

7. Finials

Hold the apex of the roof together by securing an L-bracket using 4 x 40mm screws to the underside of the front two rafters. Use the flat bracket to join the back two rafters, secure across the join on the inside of the roof using 4 x 40mm screws. Drill two holes in four finials as shown below. Attach finials over each roof and upright join, two on the front and two on the back. Drill four holes in the remaining finials, position one on the front and one on the back over the join of the two roof panels at the apex. Use 4 x 40mm screws per finial. Attach the metal roof to the upright legs using 2 x 30mm screws per leg as shown in the diagram.

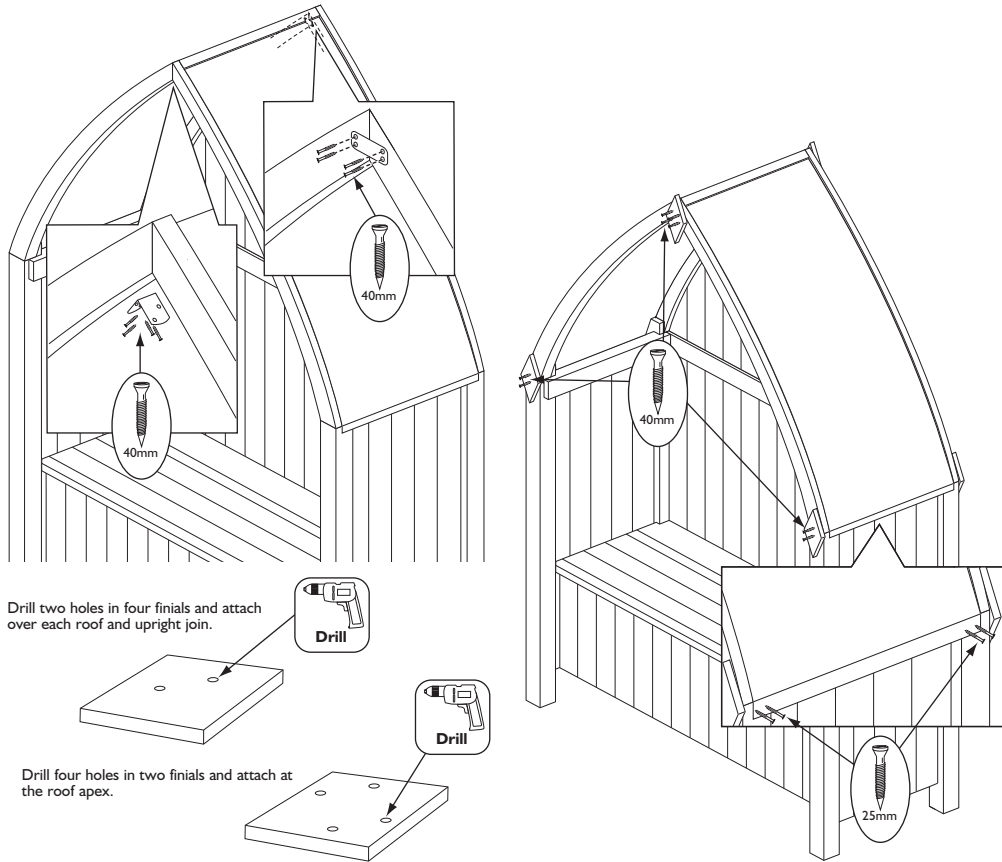

Drill two holes in four finials and attach over each roof and upright join.



Drill four holes in two finials and attach at the roof apex.

Safety information

IMPORTANT, RETAIN FOR FUTURE REFERENCE: READ CAREFULLY

Periodically check all fastenings for tightness

For domestic use only

If in doubt of any aspect regarding the assembly, use or safety of your arbour please contact us :

Help Line: (Normal Office Hours) 01829 261 121

Email: support@rowgar.co.uk

ROWLINSON GARDEN PRODUCTS LIMITED
Green Lane
Wardle Nr. Nantwich
Cheshire
CW5 6BN
www.rowgar.co.uk

We constantly improve the quality of our products, occasionally the components may differ from the components shown and are only correct at time of printing. We reserve the right to change the specification of our products without prior notice.

2015 © Rowlinson Garden Products Ltd

ROWLINSON
GARDEN PRODUCTS

Winchester Arbour

English SSI2IF

Assembly Instructions

Before assembly

- We recommend that time is taken to read the instructions before starting assembly, then follow the easy step by step guide. The instruction sheet is only a guide to the assembly. Certain items may not be shown to scale.
- Check all components prior to assembly
- This product should be assembled by no less than two people.
- Never attempt to erect the assembly in high winds.
- Drill all components where indicated.

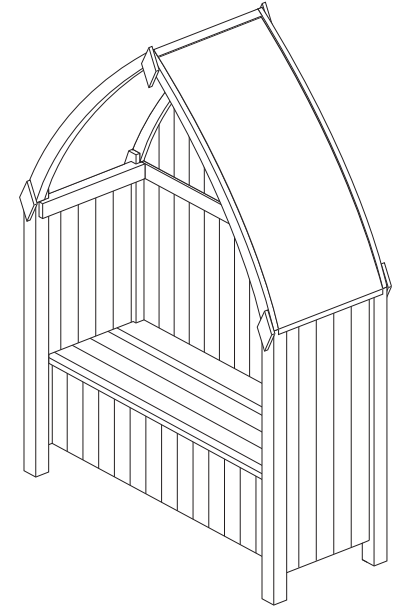

Recommended tools for assembly

- Cross head screw driver
- Drill with 3mm diameter drill bit
- Step ladder

No.	Components	Qty.
1	Floor	1
2	Seat front	1
3	Left-hand upright	1
4	Right-hand upright	1
5	Seat	1
6	Seat back	1
7	Triangular panel	1
8	Left roof panel	1
9	Right roof panel	1
10	Coverstrip	1
11	Finial	6

No.	Fixing kit	Qty.
12	70mm screws	4
13	50mm screws	10
14	40mm screws	62
15	25mm black screws	16
16	L-bracket	9
17	Flat bracket	1

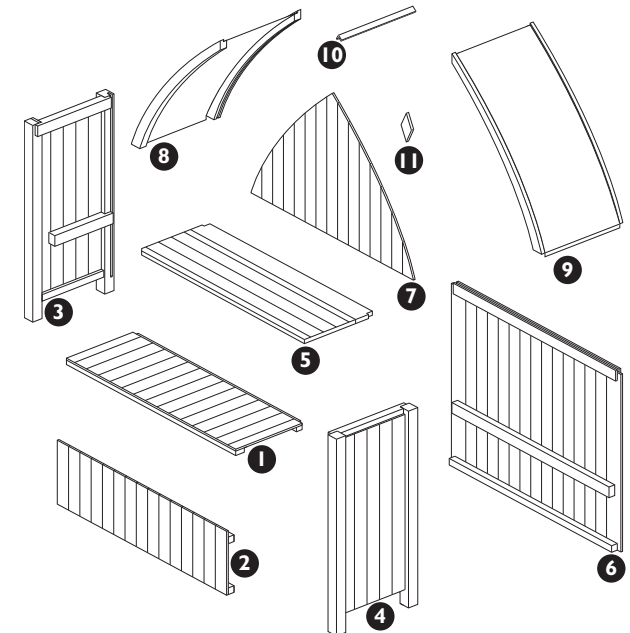

1. Seat back to uprights

Fit the back panel into the slots of the left-hand upright. Make sure the seat bearer is on the inside and that the rebated rail is at the top. Secure together by using 3 x 40mm screws, screw through the leg of the upright, ensuring the screw goes through the rebate in the leg and back panel, secure the seat bearers of the two panels with L-brackets and 4 x 40mm screws per bracket. Repeat for the right-hand upright.

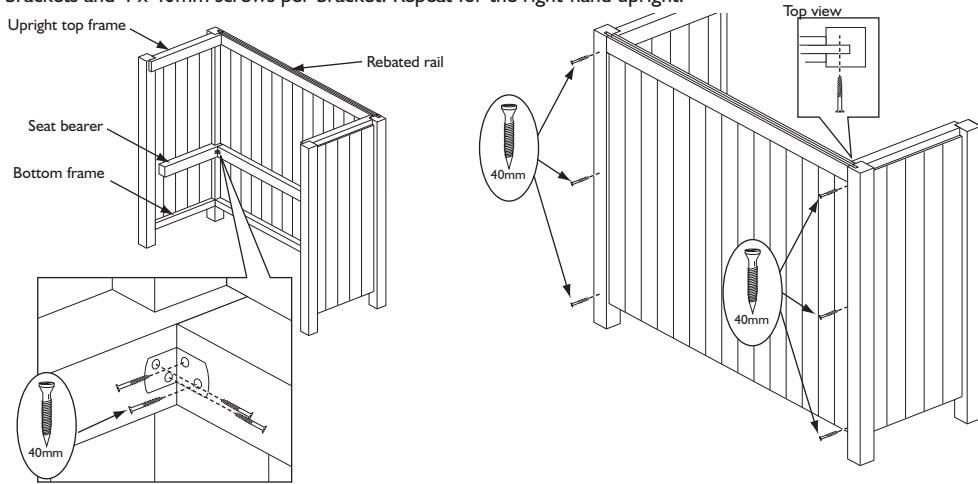

2. Seat front and floor

Fit L-brackets flush to the front end of the seat bearer on each upright as shown using 2 x 40mm screws per bracket. Prior to fitting the seat front, have the floor in place. Lift the seat front between the uprights, ensure the inset top frame is at the top see below diagram. Ensure the top of the panel is level with the top of the seat bearers and secure with the L-brackets using 2 x 40mm screw per bracket. Fix the panel at the bottom by screwing through the upright panel into the end of the framing at the bottom of the front panel using 1 x 50mm screw at each end.

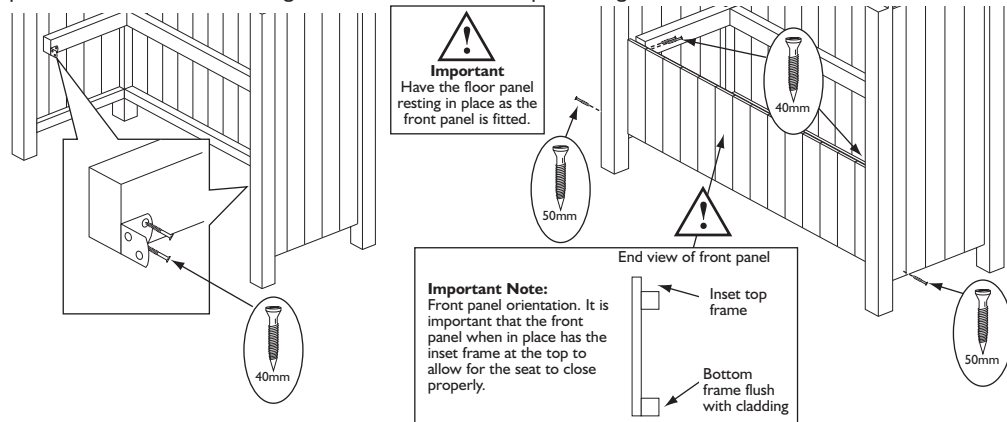

3. Secure floor

Secure the floor using 4 x 50mm screws, screw two through each upright into the ends of the floor framing. Using 4 x 70mm screws, screw two through the front and two through the back panel into the floor framing.

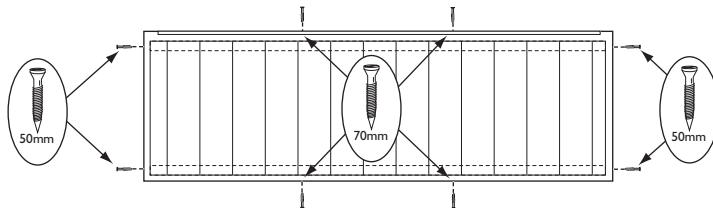

4. Seat

Place seat on the seat bearers with the hinges at the back. Make sure it is square and is able to open freely. Screw to the back panel seat bearer using 4 x 50mm screws.

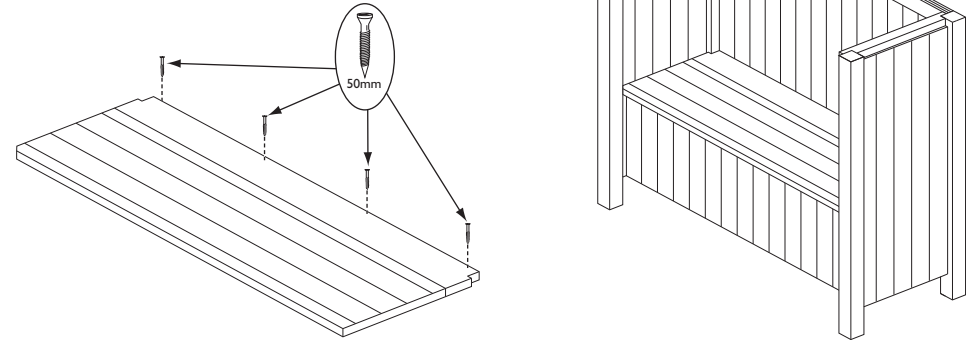

5. Roof assembly

Lift the triangular panel into the rebate of the seat back. Lift on the roof panels with the rebated rafters at the back of the arbour ensure the triangular panel fits into the rafter rebates. Mark the position of each L-bracket. Remove the roof and secure the L-brackets to the top of the uprights using 2 x 40mm screws per bracket. Replace the roof and secure through the brackets into the roof panels using 2 x 40mm per bracket.



6. Coverstrip

Place the coverstrip on the roof apex, Drill four holes in each side and secure using 4 x 30mm black screws and 4 x 25mm black screws as shown below.

